

MODEL: M28

DIRECT MOUNT MANIFOLD

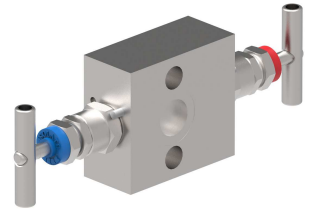

Suitable for direct mounting to gauge transmitter or one cell of a differential pressure transmitter.

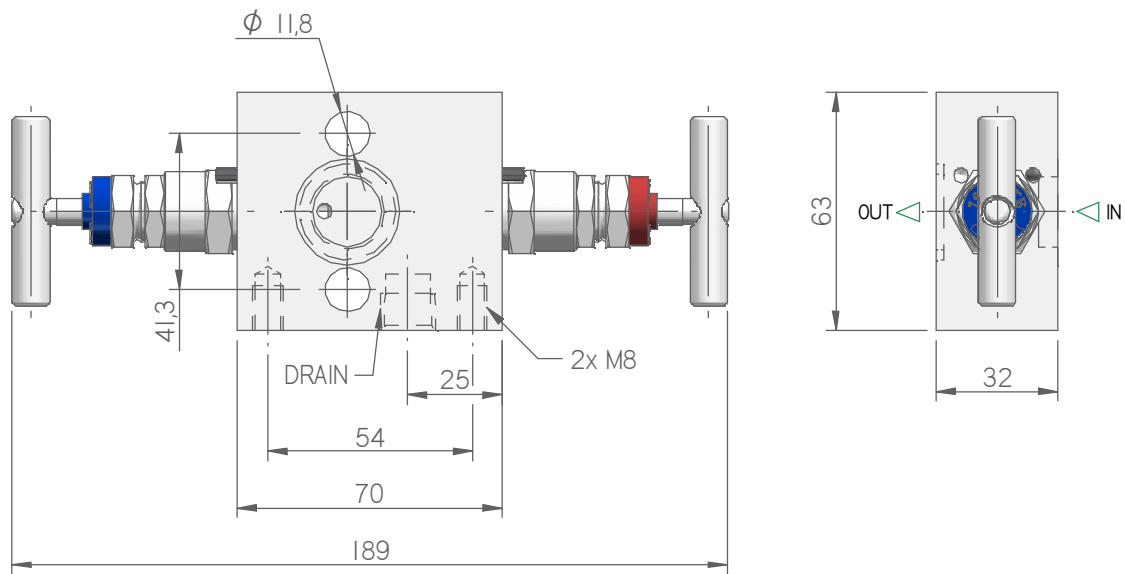
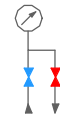

MODEL SELECTION

MODEL	RATING	MATERIAL	PACKING	IN	OUT	VENT	CODE	WEIGHT	NOTE	
M28	3K psi	AISI 316L	PTFE	IEC 61518	IEC 61518/B	1/4" NPT-F	M28-03STFLAFLB4	1,3 Kg	Packing material PTFE as standard max temperature 180 °C. The dimensions shown apply only to the illustrated valve – if you need the dimensions for your individual type or should you still not find your options at all please contact the factory.	
		ASTM A105					M28-03ATFLAFLB4			
		F51					M28-03DTFLAFLB4			
		F55					M28-03ETFLAFLB4			
		ALLOY 400					M28-03FTFLAFLB4			
		C276					M28-03GTFLAFLB4			
		6MO					M28-03HTFLAFLB4			
		I625					M28-03ITFLAFLB4			
		6K psi					AISI 316L			M28-06STFLAFLB4
							ASTM A105			M28-06ATFLAFLB4
	F51						M28-06DTFLAFLB4			
	F55						M28-06ETFLAFLB4			
	ALLOY 400						M28-06FTFLAFLB4			
	C276						M28-06GTFLAFLB4			
	6MO						M28-06HTFLAFLB4			
	I625						M28-06ITFLAFLB4			

I.T.E. s.r.l. COMMITS ITSELF TO CONSTANTLY IMPROVE ITS PRODUCTS AND THEREFORE IT RESERVES THE RIGHT TO MODIFY DATA, FEATURES WITHOUT NOTICE.

DIRECT MANIFOLD - CODIFICA

1 2 3 4 5 6 7 8 9 10 11 12 13 14 15 16

ESEMPIO:

M 2 8 - 0 6 S T F L A F L B 4

MODEL

M28 DIRECT MANIFOLD 2 VLV 70x32 I/O 180° FLG/FLG

RATING

03 Serie 3000
06 Serie 6000

MATERIAL

S Aisi 316L
A A105
D F51
E F55
F Monel 400
G C276 Hastelloy
H 6 Mo/F44
I Inconel 625

PACKING

T Teflon
G Graphoil

IN

4 1/4"
6 3/8"
8 1/2"
FL FLANGED

THREAD

N NPT
I BSPP GAS (ISO 1179)
K BSPT R/RC (ISO 7)
B Butt weld
S Socket Weld
A FLANGED

OUT

FL FLANGED

FLANGED

A FLANGED ITE
B IEC 61518 - B

DRAIN

/
4 1/4 NPT

OPTIONS

/
B All component 316L
C Prove speciali
D Custom marking
E T-Bar 316L
L Lox cleaning
TI Isolate Anti-tamper
K Padlock for all anti tamper bonnet
T Mounted plug drain
KT Padlock for all T-bar bonnet